

SAM4S

ER-180 Electronic Cash Register AU

Operation and Programming Manual

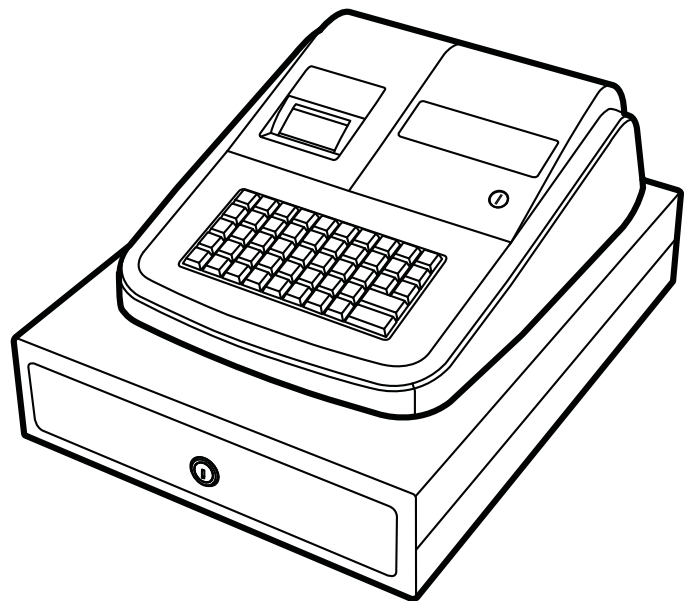

All specifications are subject to change without notice

JK68-60181A Rev. 1.12 (Oct 11)
From *ER-180* v1.000 to v1.001

ATTENTION

The product that you have purchased contains a rechargeable Ni-MH battery. This battery is recyclable. At the end of its useful life, under various state and local laws, it may be illegal to dispose of the battery into the municipal waste system.

Check with your local solid waste officials for details concerning recycling options or proper disposal.

WARNING

This is a Class A product. In a domestic environment this product may cause radio interference in which case the user may be required to take adequate measures.



CAUTION

RISK OF EXPLOSION IF BATTERY IS REPLACED BY AN INCORRECT TYPE. DISPOSE OF USED BATTERIES ACCORDING TO THE INSTRUCTIONS.

Precaution Statements

Follow these safety, servicing and ESD precautions to prevent damage and to protect against potential hazards such as electrical shock.

1-1 Safety Precautions

1. Be sure that all built-in protective devices are replaced. Restore any missing protective shields.
2. When reinstalling the chassis and its assemblies, be sure to restore all protective devices, including nonmetallic control knobs and compartment covers.
3. Make sure there are no cabinet openings through which people - particularly children - might insert fingers and contact dangerous voltages. Such openings include excessively wide cabinet ventilation slots and improperly fitted covers and drawers.
4. Design Alteration Warning:
Never alter or add to the mechanical or electrical design of the SECR. Unauthorized alterations might create a safety hazard. Also, any design changes or additions will void the manufacturer's warranty.
5. Components, parts and wiring that appear to have overheated or that are otherwise damaged should be replaced with parts that meet the original specifications. Always determine the cause of damage or over- heating, and correct any potential hazards.
6. Observe the original lead dress, especially near the following areas: sharp edges, and especially the AC and high voltage supplies. Always inspect for pinched, out-of-place, or frayed wiring. Do not change the spacing between components and the printed circuit board. Check the AC power cord for damage. Make sure that leads and components do not touch thermally hot parts.
7. Product Safety Notice:
Some electrical and mechanical parts have special safety-related characteristics that might not be obvious from visual inspection. These safety features and the protection they give might be lost if the replacement component differs from the original - even if the replacement is rated for higher voltage, wattage, etc.
Components that are critical for safety are indicated in the circuit diagram by shading, () or (). Use replacement components that have the same ratings, especially for flame resistance and dielectric strength specifications. A replacement part that does not have the same safety characteristics as the original might create shock, fire or other hazards.

CAUTION

There is the danger of explosion if battery is incorrectly replaced.

Replace only with the same or equivalent type recommended by the manufacturer.

Dispose used batteries according to the manufacturer's instructions.

ATTENTION

Il y a danger d'explosion s'il y a remplacement incorrect de la batterie.

Remplacer uniquement avec une batterie du même type ou d'un type équivalent recommandé par le constructeur.

Mettre au rebut les batteries usagées conformément aux instructions du fabricant.

SAFETY NOTICE: "For pluggable equipment, the socket-outlet shall be installed near the equipment and shall be easily accessible."

1-2 Servicing Precautions

WARNING: First read the-Safety Precautions-section of this manual. If some unforeseen circumstance creates a conflict between the servicing and safety precautions, always follow the safety precautions.

WARNING: An electrolytic capacitor installed with the wrong polarity might explode.

1. Servicing precautions are printed on the cabinet. Follow them.
2. Always unplug the units AC power cord from the AC power source before attempting to:
 - (a) Remove or reinstall any component or assembly
 - (b) Disconnect an electrical plug or connector
 - (c) Connect a test component in parallel with an electrolytic capacitor
3. Some components are raised above the printed circuit board for safety. An insulation tube or tape is sometimes used. The internal wiring is sometimes clamped to prevent contact with thermally hot components. Reinstall all such elements to their original position.
4. After servicing, always check that the screws, components and wiring have been correctly reinstalled. Make sure that the portion around the serviced part has not been damaged.
5. Check the insulation between the blades of the AC plug and accessible conductive parts (examples: metal panels and input terminals).
6. Insulation Checking Procedure: Disconnect the power cord from the AC source and turn the power switch ON. Connect an insulation resistance meter (500V) to the blades of AC plug.

The insulation resistance between each blade of the AC plug and accessible conductive parts (see above) should be greater than 1 megohm.
7. Never defeat any of the B+ voltage interlocks Do not apply AC power to the unit (or any of its assemblies) unless all solid-state heat sinks are correctly installed.
8. Always connect an instrument's ground lead to the instrument chassis ground before connecting the positive lead; always remove the instrument's ground lead last.

1-3 Precautions for Electrostatic Sensitive Devices (ESDs)

1. Some semiconductor (solid state) devices are easily damaged by static electricity. Such components are called Electrostatic Sensitive Devices (ESDs); examples include integrated circuits and some field-effect transistors. The following techniques will reduce the occurrence of component damage caused by static electricity.
2. Immediately before handling any semiconductor components or assemblies, drain the electrostatic charge from your body by touching a known earth ground. Alternatively, wear a discharging wrist-strap device. (Be sure to remove it prior to applying power - this is an electric shock precaution.)
3. After removing an ESD-equipped assembly, place it on a conductive surface such as aluminum foil to prevent accumulation of electrostatic charge.
4. Do not use Freon-propelled chemicals. These can generate electrical charges that damage ESDs.
5. Use only a grounded-tip soldering iron when soldering or unsoldering ESDs.
6. Use only an anti-static solder removal device. Many solder removal devices are not rated as anti-static; these can accumulate sufficient electrical charge to damage ESDs.
7. Do not remove a replacement ESD from its protective package until you are ready to install it. Most replacement ESDs are packaged with leads that are electrically shorted together by conductive foam, aluminum foil or other conductive materials.
8. Immediately before removing the protective material from the leads of a replacement ESD, touch the protective material to the chassis or circuit assembly into which the device will be installed.
9. Minimize body motions when handling unpackaged replacement ESDs. Motions such as brushing clothes together, or lifting a foot from a carpeted floor can generate enough static electricity to damage an ESD.

Contents

Getting Started	1
About the <i>ER-180</i>	1
Unpacking.....	1
Installing Batteries	2
Installing the Paper	3
How to Replace the Ink Roller	5
Basic Feature	6
Control Lock	6
Control Keys	6
Display	7
Keyboard	8
Key Functions	9
Memory Clear - RAM All Clear.....	10
Operating Instruction	11
Register Mode Operation Examples	11
Clerk Sign On/Sign Off	12
Sign-On	12
Sign-Off.....	12
Receipt On and Off.....	12
Calculator Function	13
No Sale Key Operation.....	14
Open Drawer	14
Non Add Number	14
Item Registrations.....	15
Department Entry - Open Price	15
Department Entry - Preset Price	15
Department Entry - Open Price Multiplication	16
Department Entry - Preset Price Multiplication	16
PLU Entry - Open Price	17
PLU Entry - Preset Price	17
PLU Entry - Open Price Multiplication.....	18
PLU Entry - Preset Price Multiplication.....	18
Minus (–) Key Operation.....	19
Single Minus Operation.....	19
Multiple Minus Operation	19
Percent Operation (-% and +%).....	20
Percent Discount on Item	20
Percent Discount on Entire Sale	20
Merchandise Return Operation.....	21
Voiding Entries (Void)	22
Void Last Item / Error Correct	22
Previous Item Void.....	22

Tendering Operation	23
Cash Tender.....	23
Amount Tendered On Cash	23
Amount Tendered On Check	24
Charge Tender	24
Amount Tendered On Charge	25
Split Tender	25
Received on Account (RA) Operation	26
Paid Out (PO) Operation	26
Currency Conversion Operation	26
Receipt On and Off.....	27
Calculator Function.....	27

X/Z Mode Reporting 29

Management Reports and Balancing	29
Financial Daily Report.....	30
Financial Z2 Report	30
P-T-D Grand Total Report.....	31
Department Report.....	31
Clerk Report.....	31
Cash In Drawer Declaration	32

Program Mode Programming 33

Tax, Decimal Point Information	33
Tax Rate.....	34
Link Plu to Department.....	34
Status and Preset Price of Plu & Department	35
Setting the Percent (%) Key.....	36
Setting the Machine Number	36
Receipt Print / Journal Print.....	37
Rounding Option	37
Training Mode	38
System Options	39
Setting the Date.....	40
Currency Conversion Rate.....	40
System Balancing	41
Maintenance.....	41

Getting Started

About the *ER-180*

The *Sam4S ER-180* features a 48-position keyboard with traditional raised keys. This keyboard accommodates 16 Departments and works best in retail stores, or shop where it is not necessary to place a large number of preset price items on the keyboard.

Unpacking

1. Unpack and unwrap cash register.
2. Locate in the packing the following items.
 - 1 DC power supply
 - 1 roll of paper
 - 1 set of control keys (5 pcs., REG, VD, Z, P, C one of each)
 - 3 AA size batteries
 - This Operation and Programming Manual
 - 1 rewind spindle for journal tape
3. Plug the register DC power supply into a grounded outlet, connect the cord to the right-hand-side of the register, insert a control key and turn the control key to accessible location(s) with the key.

Installing Batteries

1. Remove batteries from the packaging.
2. Remove the battery cover.
3. Push negative pole of battery against spring firmly (A) and (B).



↑(A)



↑(B)

4. Push positive pole into position (C) (there should be a gap between Positive pole and positive pole spring).



↑(C)



↑(D)

5. Release battery and the positive pole is now contact the spring of positive pole (D).
6. Repeat step 3 to 5 for the second and the third battery, then replace the battery cover.
7. If batteries are not installed correctly, an “**E Lo 0.00**” will appear on the display after power adaptor is plugged in.

Installing the Paper

1. Remove the printer cover (A) and (B).

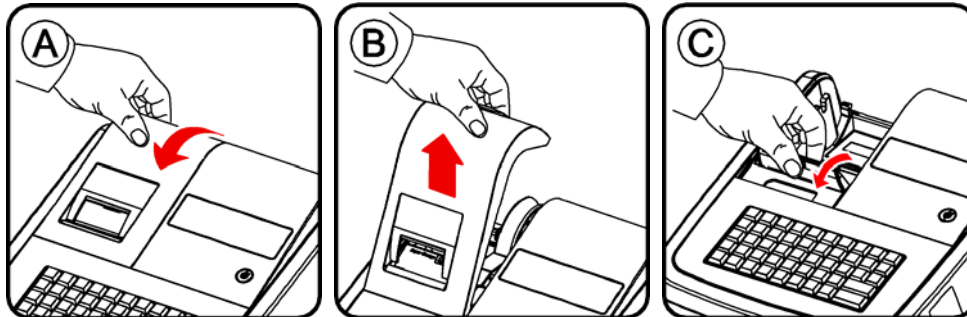

2. Lift the cover and insert the paper roll (C).
3. Cut or tear the end of a single paper tape evenly for proper feeding through the print head (D).

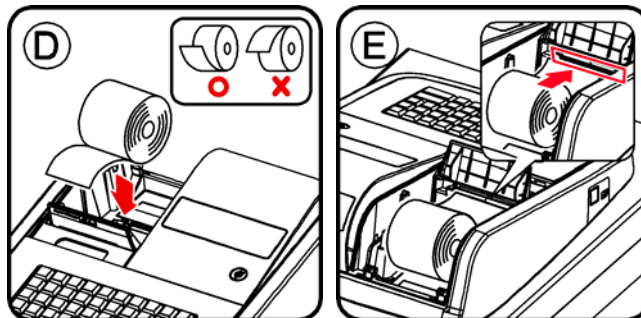

4. Place paper roll in the paper holder and insert the paper end straight into the paper inlet of the printer (E).
5. Depress the **FEED** key until the paper catches and advances through the printer (F).

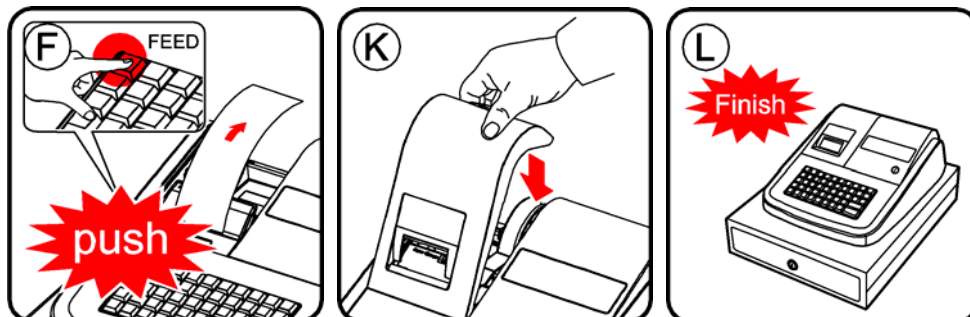

NOTE: If the paper does not feed through the printer, make sure the paper was entered properly, insert end of paper tape.

FOR RECEIPT ONLY...

6. Pass the paper through the receipt window of the printer cover. Replace over printer compartment (K) and (L).

FOR JOURNAL ONLY...

NOTE: Paper take-up spool is optional.

7. Press **FEED** key to advance paper.

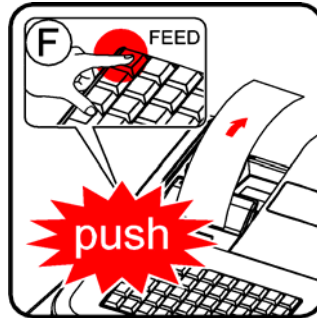

8. Route paper over top of paper guide insert in the slot of the take-up spool (G) ~ (J).

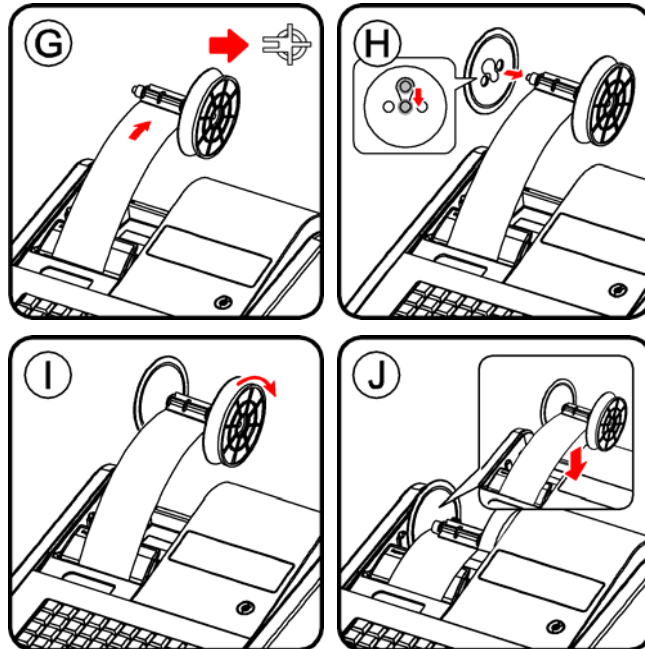

9. Replace printer cover (K) (L).

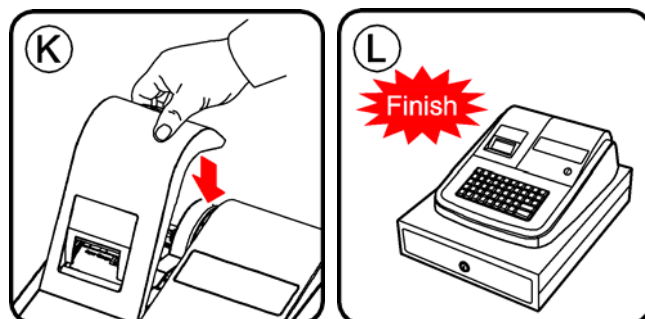

How to Replace the Ink Roller

The ink roller is a one-time article. Re-inking roller can cause damage to the printer and void warranty. Do not re-ink. When the print becomes faint, replace the ink roller as follows.

1. Remove the old roller by lifting of it.
2. Fit the new ink roller completely.

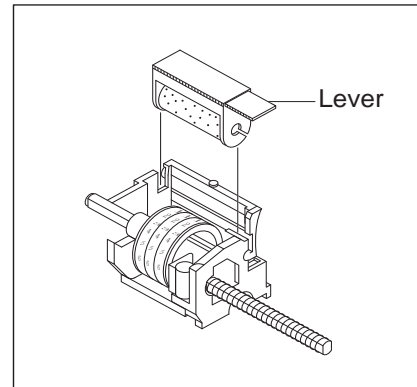

Basic Feature

Control Lock

The control lock has 7 positions, accessed with 5 keys. Each ECR is shipped with two full sets of keys.

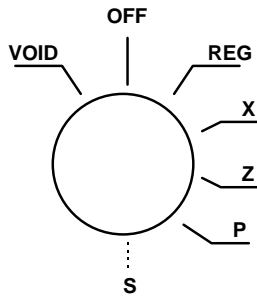

- VOID** Use to void (correct) items outside of a sale.
- OFF** The register is inoperable.
- REG** Use for normal registrations.
- X** Use to read register reports.
- Z** Use to read register reports and reset totals to zero.
- P** Use to program the register.
- S** **The S position is a hidden position reserved for dealer access.**

Before performing any operations in Register Mode a clerk must be signed on. See “**Clerk Sign-On/Sign-Off**” for a description of clerk operations.

Control Keys

The *ER-180* includes two sets of keys that may be used to access the following control lock positions.

Key	Positions Accessible						
	VOID	OFF	REG	X	Z	PGM	S
Removable		√	√				
REG		√	√				
VD	√	√	√				
Z	√	√	√	√	√		
P	√	√	√	√	√	√	
C	√	√	√	√	√	√	√

Display

The ER-180 comes with 8 digit florescent display on both front and rear.

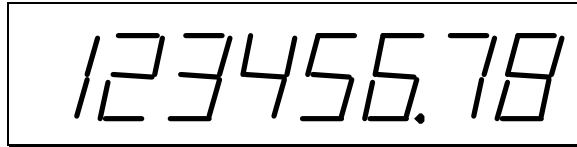

Both displays offer supplemental descriptors, which appear in the first two display positions (as shown). These descriptors help the operator and customer by supplying additional information while operating the register, and may be accompanied by an error tone.

Supplemental descriptors include:

REG - Closed



Change Due

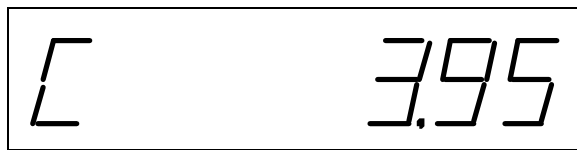

Negative Entry



Subtotal

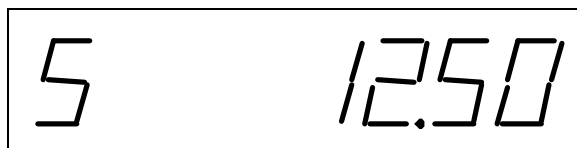

Total of Sale

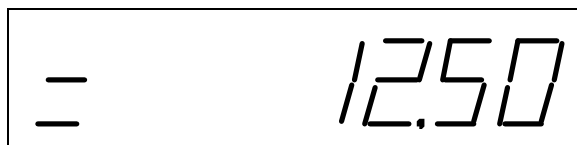

Error Conditions



System Error – Please see your dealer

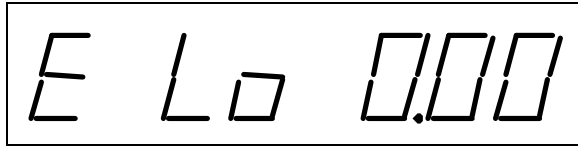

Keyboard

FEED	CLEAR	PLU	X/TIME (X)	RCPT ON/OFF C/CONV	-	- %	+ %	NO SALE	CALC
RETURN	7	8	9	1	5	9	13	RA (+)	PO (-)
VOID	4	5	6	2	6	10	14	CHECK	CHARGE
CLERK	1	2	3	3	7	11	15	SUB TOTAL	
TAX	0	00	.	4	8	12	16	CASH / TEND (=)	

Key Functions

FEED	Used to advance printer paper.
0 - 9, 00	Used to enter the number.
DEPT	These keys classify the items sold and 1-16 memorize the quantities and amounts in their own memories.
X/TIME	Used for multiplication entry. (X)
RETURN	To allow for the return of merchandise
PO	To register any money paid out.
RA	To register any money received on account.
CLERK	To log in/out for clerk 1,2,3,4
PLU	To register PLU entries
-	To register an amount minus or coupon.
-%	To register a percent discount (-%) on an item or on a sale.
+%	To register surcharge (+%) on an item or on a sale.
VOID	To correct entries before a sale is finalized.
CLEAR	To clear incorrect entries made on the numeric keys. Also to clear error conditions and silence the error tone.
TAX	To program the tax rate in PGM mode. Also to enter the rate of tax in external straight tax method in R mode.
RCPT	To toggle receipt on and off status
ON/OFF	To use currency conversion function
C/CONV	
NOSALE	To print the reference number or to open the cash drawer outside of a sale.
CHECK	To finalize the transaction in check sales.
CHARGE	To finalize the transaction in charge sales.
SUBTOTAL	To obtain the subtotal of a sale.
CASH/TEND	To finalize cash sale and change calculation.
CALC	To start calculation mode in REG MODE.
RA	To add (In the calculation mode).
X/TIME	To multiply (In the calculation mode).
PO	To subtract (In the calculation mode).
CASH	To Calculate and display result (In the calculation mode).

Memory Clear - RAM All Clear

1. Place mode key in **S** position (this is a hidden position - one more position after **PGM**). Please see **Getting Start, Basic Feature - Control Lock**.
2. Connect the AC plug into a power outlet while pressing the "00" button, you should hear 2 BEEP! sounds.

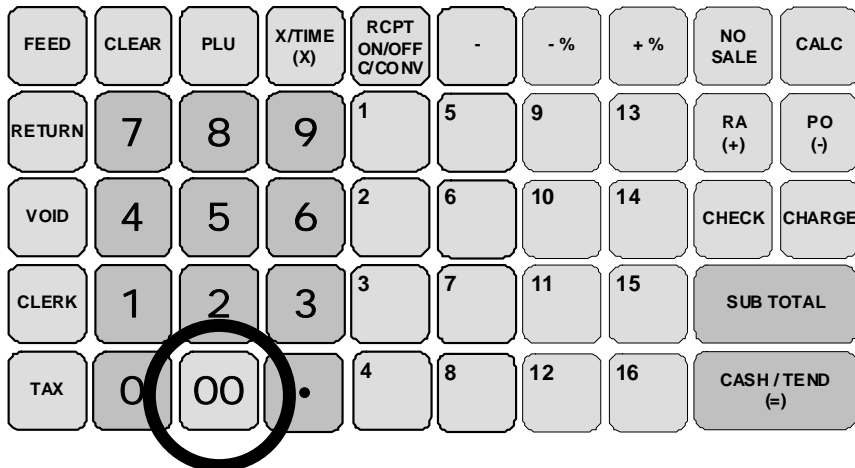

3. An eight digit number will show on the display, a receipt will print by cash register.

SAMPLE RECEIPT

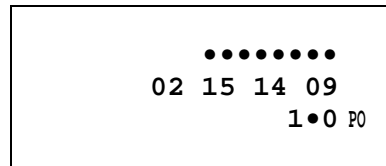

4. The RAM All Clear is now complete.

NOTE: This is a one time only procedure to be performed after the battery is installed. **DO NOT CLEAR RAM AFTER THE CASH REGISTER IS PROGRAMMED. TO DO SO WOULD CAUSE ALL PROGRAMS AND TOTALS TO BE LOST.**

Operating Instruction

Register Mode Operation Examples

- Mode key sets to **REG** position

This section provides examples of practice in the register mode. When an error occurs, the symbol "E" will appear on the display accompanied by an error tone. Clear this error condition by pressing the **CLEAR** key. The Error prompt may indicate an incorrect key has been entered, or a compulsory function has been performed.

SAMPLE RECEIPT

VAT version

02-01-10	14-30
	001 #
	1•00 TX1
	002 #
	2•00 TX2
	003 #
	3•00 TX3
	6•00 CA
	1•00 TX1
	0•04 TX1
	2•00 TX2
	0•11 TX2
	3•00 TX3
	0•22 TX3
	001-00 1

Add - on tax version

02-01-10	14-30
	001 #
	1•00 TX1
	002 #
	2•00 TX2
	003 #
	3•00 TX3
	1•00 TX1
	0•04 TX1
	2•00 TX2
	0•12 TX2
	3•00 TX3
	0•24 TX3
	6•40 CA
	001-00 1

- Following example are based on VAT version.

Clerk Sign On/Sign Off

When you see **CLOSEd** on the display, a clerk needed to sign on in order to use register.

To sign On/Off Clerk, need to turn key to **REG** Mode.

Sign-On

To sign on, enter the clerk number and press the **CLERK** key.

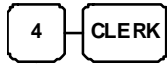

Clerk # (1 - 4)

Sign-Off

To sign the clerk off, Enter 0 (Zero) and press the **CLERK** key.

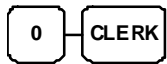

Receipt On and Off

On *ER-180*, the receipt printer can be switched ON/OFF in **REG** Mode. All reports in X/Z Mode will still print even the receipt printer has been turned off. To switch receipt printer ON/OFF,



1. Press the **RECEIPT ON/OFF** key once to turn the receipt *off*.
2. Press the **RECEIPT ON/OFF** key again to turn the receipt *on*.

Calculator Function

You can use the *ER-180* to perform simple addition, subtraction and multiplication calculator functions outside of a sale.

Turn the mode key to **REG** Mode and press **CALC** key. To exit from Calculator mode, press **CLEAR** key or turn the mode key to other modes.

- Press the **CALC** key to enter calculator mode:

CALC

Addition

Enter amount, press **RA (+)** Enter amount, press **CASH/TEND (=)**

Subtraction

Enter amount, press **PO (-)** Enter amount, press **CASH/TEND (=)**

Multiplication

Enter amount, press **X/TIME (x)** Enter amount, press **CASH/TEND (=)**

- Press the **CLEAR** key to exit calculator mode:

CLEAR

No Sale Key Operation

Open Drawer

A no sales operation opens the cash drawer outside of a sale. The financial report records the no sale activity counter.

1. Press #/NS:



The drawer will open and the receipt will print as in the example on the right.

SAMPLE RECEIPT

02-01-10	14-30
••••••••	NS
002-00	1

Non Add Number

The **NO SALE** key can be used as “**NON ADD NUMBER ENTRIES**” to enter up 7 digits. The entry can be made prior to any operation in the register mode. This numeric entry will not add to any activity counts or totals.

1. Enter the number you wish to record, for example enter:



2. Press #/NS:



3. Register the items you wish to sell.

SAMPLE RECEIPT

02-01-10	14-30
12•34	#

...continuous with item(s)
registration

Item Registrations

Item registrations on **ER-180** are made into Open or Preset Price with Departments and PLUs.

- All Departments are located on the keyboard for directly access.
- All PLUs are only accessed by entering the PLU code number, then pressing **PLU** function key on the keyboard.

The key sequence for Non-Single Item Department/PLU and Single Item Department/PLU are the same. The cash drawer will open immediately after a Single Item Department/PLU is registered without tender key. However, if another Non-Single Item Department/PLU has already been entered, a Single Item Department/PLU will not process as a single item sale. The register will expect a tender key to be pressed to finalise the transaction.

To perform a item registration, need to turn control lock to **REG-Mode** if there is no specific instruction given.

Department Entry - Open Price

1. Enter an amount on the ten key pad. *Do not use the decimal key.*

For example, for \$2.99, enter:

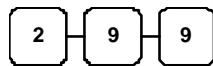

2. Press a Department key.

For example, press **DEPT1**:



SAMPLE RECEIPT

02-01-10	14-30
	001 #
	2•99 TX1
	3•00 CA
	2•99 TX1
	0•27 TX1
	004-00 1

Department Entry - Preset Price

1. Press a preset Department key.

For example, press **DEPT5**:



SAMPLE RECEIPT

02-01-10	14-30
	005 #
	2•99 TX1
	3•00 CA
	2•99 TX1
	0•27 TX1
	005-00 1

Department Entry - Open Price Multiplication

1. Enter the quantity of items being purchased, press the **X/TIME** key.
For example, enter **4** on the numeric key pad and press the **X/TIME** key:

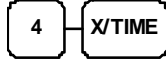

2. Enter an amount on the ten key pad. *Do not use the decimal key.*

For example, for \$1.99, enter:

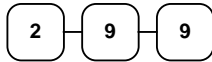

3. Press a Department key.

For example, press **DEPT1**:



SAMPLE RECEIPT

02-01-10	14-30	
	4	X
	2•00	
	001	#
	8•00	TX1
	8•00	CA
	8•00	TX1
	0•73	TX1
	006-00	1

Department Entry - Preset Price Multiplication

1. Enter the quantity of items being purchased, press the **X/TIME** key.
For example, enter **4** on the numeric key pad and press the **X/TIME** key:

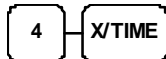

2. Press a Department key.

For example, press **DEPT1**:



SAMPLE RECEIPT

02-01-10	14-30	
	4	X
	2•99	
	005	#
	11•96	TX1
	11•95	CA
	11•96	TX1
	1•09	TX1
	007-00	1

PLU Entry - Open Price

1. Enter the PLU number; press the **PLU** key.

For example, enter:



2. Enter an amount on the ten key pad. *Do not use the decimal key.*

For example, for \$2.99, enter:

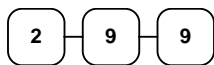

3. Press the **PLU** key again.



SAMPLE RECEIPT

02-01-10	14-30
	001 *#
	2•99 TX1
	3•00 CA
	2•99 TX1
	0•27 TX1
008-00	1

PLU Entry - Preset Price

1. Enter the PLU number; press the **PLU** key.

For example, enter:



SAMPLE RECEIPT

02-01-10	14-30
	002 *#
	2•99 TX1
	3•00 CA
	2•99 TX1
	0•27 TX1
009-00	1

PLU Entry - Open Price Multiplication

1. Enter the quantity of items being purchased, press the **X/TIME** key.

For example, enter **4** on the numeric key pad and press the **X/TIME** key:

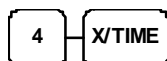

2. Enter the PLU number; press the **PLU** key.

For example, enter:



SAMPLE RECEIPT

02-01-10	14-30
	4 X
	2•99
	001 *#
	11•96 TX1
	11•95 CA
	11•96 TX1
	1•09 TX1
	010-00 1

PLU Entry - Preset Price Multiplication

1. Enter the quantity of items being purchased, press the **X/TIME** key.

For example, enter **4** on the numeric key pad and press the **X/TIME** key:

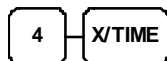

2. Enter an amount on the ten key pad. *Do not use the decimal key.*

For example, for \$1.99, enter:

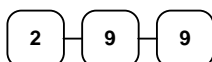

3. Enter the PLU number; press the **PLU** key.

For example, enter:



SAMPLE RECEIPT

02-01-10	14-30
	4 X
	2•99
	002 *#
	11•96 TX1
	11•95 CA
	11•96 TX1
	1•09 TX1
	011-00 1

Minus (–) Key Operation

Single Minus Operation

1. Press a preset Department key.

For example, press **DEPT5**:



2. Enter an amount on the ten key pad. *Do not use the decimal key.*

For example, for \$0.50 discount, enter:



SAMPLE RECEIPT

02-01-10	14-30
	005 #
	5•00 TX1
	-0•50 -
	4•50 CA
	5•00 TX1
	0•45 TX1
	012-00 1

Multiple Minus Operation

1. Press a preset Department key.

For example, press **DEPT5**:



2. Enter the quantity of discount is offered, press the **X/TIME** key.

For example, enter **4** on the numeric key pad and press the **X/TIME** key:

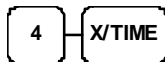

3. Enter an amount on the ten key pad. *Do not use the decimal key.*

For example, for \$0.50 discount, enter:



SAMPLE RECEIPT

02-01-10	14-30
	005 #
	5•00 TX1
	4 X
	-0•50 -
	-2•00 -
	3•00 CA
	5•00 TX1
	0•45 TX1
	013-00 1

Percent Operation (-% and +%)

ER-180 equipped with both -% and +% function keys. The -% can be used as discount and +% is for surcharge. This section is using -% (discount) as example, +% is operating in same way, but is adding amount as surcharge.

The examples use a preset value on the discount key. If a override value is needed or -% and +% are set open, enter amount before press -% or +% key. For example, "30" for "30"%; "7.5" for "7.5"%; and "33.333" for "33.333"% (*1/3 discount or surcharge*).

Percent Discount on Item

1. Enter an amount on the ten key pad. *Do not use the decimal key.*

For example, for \$2.99, enter:

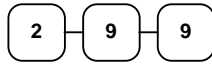

2. Press a Department key.

For example, press **DEPT1**:



3. Press -% key.



SAMPLE RECEIPT

02-01-10	14-30	
	001	#
	2•99	TX1
	-3•000	-
	-0•09	
	2•90	CA
	2•99	TX1
	0•27	TX1
	014-00	1

Percent Discount on Entire Sale

1. Register the item(s) for the transaction.
2. Press **SUBTOTAL** key.



3. Press -% key.



SAMPLE RECEIPT

02-01-10	14-30	
	001	#
	2•99	TX1
	002	#
	4•00	TX1
	7•00	ST
	-3•000	-
	-0•21	
	6•80	CA
	6•99	TX1
	0•64	TX1
	015-00	1

Merchandise Return Operation

1. Press **RETURN**:

RETURN

2. Enter the price of the item you wish to return, and then press the Department key where it was registered originally.

2 0 0 DEPT2

3. Total the sale with **CASH**, **CHECK**, or a **CHARGE** function.

SAMPLE RECEIPT

```
02-01-10 14-30
      ..... RF
          001 #
        -2.00 TX1
        -2.00 CA
        -2.00 TX1
        -0.18 TX1
        016-00 1
```

Voiding Entries (Void)

Void Last Item / Error Correct

1. Register the item(s) for the transaction.
2. To void last item, press **VOID** key.



SAMPLE RECEIPT

```
02-01-10  14-30
           001 #
           1•00 TX1
           002 #
           2•00 TX1
           •••••••• VD
           002 #
          -2•00 TX1
           1•00 CA
           1•00 TX1
           0•09 TX1
          017-00  1
```

Previous Item Void

1. Register the item(s) for the transaction.
2. To void previous item, enter the price of the item going to be voided.

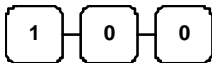

3. Then press **VOID** key.



SAMPLE RECEIPT

```
02-01-10  14-30
           001 #
           1•00 TX1
           002 #
           2•00 TX1
           •••••••• VD
           001 #
          -1•00 TX1
           2•00 CA
           2•00 TX1
           0•18 TX1
          018-00  1
```

Tendering Operation

Cash Tender

1. Register the item(s) for the transaction.
2. To total a cash sale, press **CASH**:

CASH

3. The display will indicate the total amount of the cash sale.

SAMPLE RECEIPT

02-01-10	14-30
	001 #
	2•99 TX1
	3•00 CA
	2•99 TX1
	0•27 TX1
	019-00 1

Amount Tendered On Cash

1. Register the item(s) for the transaction.
2. Enter the amount tendered by the customer.

For example, for \$5.00 enter:

5 0 0

3. Press **CASH**:

CASH

4. The display will indicate the total amount of the cash tendered and the change due, if any.

SAMPLE RECEIPT

02-01-10	14-30
	001 #
	2•99 TX1
	3•00 TA
	5•00 AT
	2•00 CG
	2•99 TX1
	0•27 TX1
	020-00 1

Check Tender

1. Register the item(s) for the transaction.
2. To total a cash sale, press **CHECK**:

CHECK

3. The display will indicate the total amount of the cash sale.

SAMPLE RECEIPT

02-01-10	14-30
	001 #
	2•99 TX1
	3•00 CH
	2•99 TX1
	0•27 TX1
	021-00 1

Amount Tendered On Check

1. Register the item(s) for the transaction.
2. Enter the amount tendered by the customer.

For example, for \$5.00 enter:

5 0 0

3. Press **CHECK**:

CHECK

4. The display will indicate the total amount of the cash tendered and the change due, if any.

SAMPLE RECEIPT

02-01-10	14-30
	001 #
	2•99 TX1
	3•00 TA
	5•00 AT
	2•00 CG
	2•99 TX1
	0•27 TX1
	022-00 1

Charge Tender

1. Register the item(s) for the transaction.
2. To total a cash sale, press **CHARGE**:

CHARGE

3. The display will indicate the total amount of the cash sale.

SAMPLE RECEIPT

02-01-10	14-30
	001 #
	2•99 TX1
	3•00 CG
	2•99 TX1
	0•27 TX1
	023-00 1

Amount Tendered On Charge

1. Register the item(s) for the transaction.
2. Enter the amount tendered by the customer.

For example, for \$5.00 enter:

5 0 0

3. Press **CHARGE**:

CHARGE

4. The display will indicate the total amount of the cash tendered and the change due, if any.

SAMPLE RECEIPT

02-01-10	14-30
	001 #
	2•99 TX1
	3•00 TA
	5•00 AT
	2•00 CG
	2•99 TX1
	0•27 TX1
	024-00 1

Split Tender

NOTE: The cash drawer should not open during split tender.

1. Register the item(s) for the transaction.
2. Enter the amount of cash tendered by the customer.

For example, enter \$2.00 and press

CASH:

2 0 0 CASH

3. The display will indicate the \$2.00 cash tender and the \$2.00 total still due.
4. Enter the amount of check tendered by the customer.

For example, enter \$2.00 and press

CHECK:

2 0 0 CHECK

5. When the total tendered equals or exceeds the total due, the receipt will print and the transaction is complete.

SAMPLE RECEIPT

02-01-10	14-30
	001 #
	4•00 TX1
	4•00 TA
	2•00 AT
	2•00 TA
	2•00 AT
	4•00 TX1
	0•36 TX1
	025-00 1

Received on Account (RA) Operation

1. Enter amount received, then press **RA**.

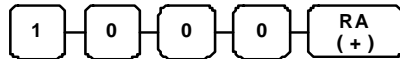

SAMPLE RECEIPT

02-01-10	14-30
	10•00 RA
	026-00 1

Paid Out (PO) Operation

1. Enter amount received, then press **RA**.

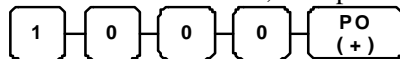

SAMPLE RECEIPT

02-01-10	14-30
	10•00 PO
	027-00 1

Currency Conversion Operation

NOTE: This feature requires preset conversion rate pre-programmed.

1. Register the item(s) for the transaction.
2. Press **C/CONV**, the preset convert rate will shown on the display,

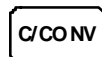

3. Enter amount of foreign currency, then press **CASH**,

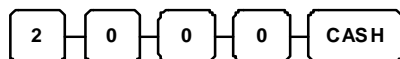

4. The transaction will be finalised, drawer open and home currency change amount shown on the display.

SAMPLE RECEIPT

02-01-10	14-30
	001 #
	1•00 TX1
	1•00 TA
	13•72 @
	1•46 PO
	0•45 CG
	1•00 TX1
	0•09 TX1
	028-00 1

Receipt On and Off

On *ER-180*, the receipt printer can be switched ON/OFF in **REG** Mode. All reports in X/Z Mode will still print even the receipt printer has been turned off. To switch receipt printer ON/OFF,



1. Press the **RECEIPT ON/OFF** key once to turn the receipt *off*.
2. Press the **RECEIPT ON/OFF** key again to turn the receipt *on*.

Calculator Function

You can use the *ER-180* to perform simple addition, subtraction and multiplication calculator functions outside of a sale.

Turn the mode key to **REG** Mode and press **CALC** key. To exit from Calculator mode, press **CLEAR** key or turn the mode key to other modes.

- Press the **CALC** key to enter calculator mode:

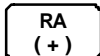
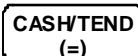

Addition

Enter amount, press  Enter amount, press 

Subtraction

Enter amount, press  Enter amount, press 

Multiplication

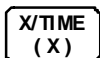
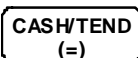
Enter amount, press  Enter amount, press 

- Press the **CLEAR** key to exit calculator mode:



X/Z Mode Reporting

Management Reports and Balancing

All Management Functions take place with the control lock in the **X** position. In this way only those with the correct key will have access to these functions. Some register operations may be programmed to require the control lock in the **X** position in order to operate. All reports require a key that will access the **X** or **Z** position.

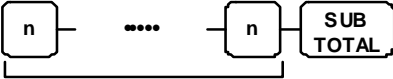
Report	Control Lock Position	Key
Financial	X or Z	CASH/ TEND
Financial Level 2	X or Z	VOID
Period-to-Date Financial	X or Z	CHECK
Department	X or Z	CHARGE
Clerk	X or Z	CLERK
Cash in Drawer	X	 Up to 8 digits number for amount

Financial Daily Report

		<i>SAMPLE RECEIPT</i>	
DATE ->	02-01-10	14-30	
REPORT COUNTER, X or Z MODE ->		1	Z
TAXABLE1 TOTAL ->		54•00	TX1
TAX1 TOTAL ->		2•08	TX1
TAXABLE2 TOTAL ->		19•00	TX2
TAX2 TOTAL ->		1•07	TX2
TAXABLE3 TOTAL ->		3•00	TX3
TAX3 TOTAL ->		0•22	TX3
TAXABLE4 TOTAL ->		3•00	TX4
TAX4 TOTAL ->		0•22	TX4
-PERCENT TOTAL ->		-0•24	%-
+PERCENT TOTAL ->		0•20	%+
(-) TOTAL ->		-7•50	-
NET SALES TOTAL ->		188•26	*1
RETURN MERCHANDISE TOTAL ->		-2•00	RF
VOID TOTAL ->		-3•00	RF
GROSS SALES TOTAL ->		198•00	*2
CUSTOMER COUNTER ->		018	#
CASH TOTAL ->		183•26	CA
CHECK TOTAL ->		5•00	CH
CHARGE TOTAL ->		0•00	CG
RECEIVED ON ACCOUNT ->		7•00	RA
PAID OUT ->		5•00	PO
CASH IN DRAWER ->		184•26	AT
NO SALE COUNTER ->		001	NS
		••••••••	
GRAND TOTAL ->		198•00	*3
RECEIPT NUMBER, MACHINE NO. CLERK ->		027-00	1
NUMBER			

Financial Z2 Report

		<i>SAMPLE RECEIPT</i>	
DATE ->	02-01-10	14-30	
REPORT COUNTER, X or Z MODE ->		1	Z
NET SALES TOTAL ->		188•26	*1
CUSTOMER COUNTER ->		198•00	*2
RECEIPT NUMBER, MACHINE NO. CLERK ->		028-00	1
NUMBER			

P-T-D Grand Total Report

	DATE ->	02-01-10	14-30	
REPORT COUNTER, X or Z MODE ->				1 *Z
P-T-D GRAND TOTAL ->				198•00 *4
RECEIPT NUMBER, MACHINE NO. CLERK ->				029-00 1
NUMBER				

SAMPLE RECEIPT

Department Report

	DATE ->	02-01-10	14-30	
REPORT COUNTER, X or Z MODE ->				1 Z
DEPARTMENT NUMBER ->				001 #
DEPARTMENT COUNTER ->				003 @
TOTAL ->				19•00
DEPARTMENT NUMBER ->				002 #
DEPARTMENT COUNTER ->				002 @
TOTAL ->				29•00
DEPARTMENT NUMBER ->				016 #
DEPARTMENT COUNTER ->				005 @
TOTAL ->				20•00
RECEIPT NUMBER, MACHINE NO. CLERK ->				029-00 1
NUMBER				

SAMPLE RECEIPT

Clerk Report

	DATE ->	02-01-10	14-30	
REPORT COUNTER, X or Z MODE ->				1 Z
NET SALES OF CLERK 1 , CLERK 1 ->				25•00 1
NET SALES OF CLERK 2 , CLERK 2 ->				30•00 2
NET SALES OF CLERK 3 , CLERK 3 ->				59•00 3
NET SALES OF CLERK 4 , CLERK 4 ->				100•00 4
RECEIPT NUMBER, MACHINE NO. CLERK ->				029-00 1
NUMBER				

SAMPLE RECEIPT

Cash In Drawer Declaration

In the **System Option #1 Programming**, cash-in-drawer declaration can be programmed compulsory. Cash-in-drawer declaration is performed by adding the total of each type of media in the drawer, and pressing the **SUBTOTAL** key. Depression of the **SUBTOTAL** key with numeric will enter the information that the cash-in-drawer declaration performed, and reports in X position and Z position will be allowed. In this case, the difference of input amount and cash in drawer is displayed. After this declaration, you can not take any registering operation, if not reporting in X mode or Z mode.

SAMPLE RECEIPT

TOTAL ENTERED BY KEY-INPUT ->	02-01-10	14-30
TOTAL IN CASH DRAWER ->		180•00 CA
DIFFERENCE ->		184•26 AT1
		-4•26
		029-00

Program Mode Programming

Read this entire section carefully to program the machine to the most preferable set-up according to your store system. In each program, all option(s) (N1, N2, N3... until last one) need to be considered and decided together then entered all at once.

The mode key position is **PGM** if any setting change procedure is needed.

Tax, Decimal Point Information

The features involved in this programming on the *ER-180* have been preset for Australia use (**Bold Font**). If change is needed, please refer to the table below; find out the best option for both N1 and N2 from the table below, then,

1. Turn mode key to **PGM** mode,
2. Enter the number of your option of N1, then N2,

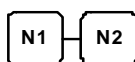

3. Press **X/TIME** key to finalise the programming.



	VALUE
N1	0 = 2 decimal 1 = non decimal 2 = 1 decimal 3 = 3 decimal
N2	0 = VAT 1 = add-on tax 2 = external straight tax

Tax Rate

The tax rate on the *ER-180* has been preset to 10% Tax1 (VAT or add-on) as GST (**Bold Font**). If change is needed, please refer to the table below, then,

1. Turn mode key to **PGM** mode,
2. Enter the tax rate up to 5 digits number (*Do Not Use Decimal Point!*),

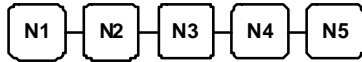

3. Enter the option of Status,



4. Press Department key for the department you are programming for to finalise the programming.



	VALUE	COMMENTS
N1-N5	00000 - 99999 (10000 for 10%)	Tax rate
N6	0	External straight tax
	1	Tax1 (VAT or add-on)
	2	Tax2 (VAT or add-on)
	3	Tax3 (VAT or add-on)
	4	Tax4 (VAT or add-on)

Link Plu to Department

All 100 PLUs in *ER-180* are preset link to Department 1. If change is needed,

1. Turn mode key to **PGM** mode,
2. Enter the PLU number of the PLU that is modified, then **PLU** function key,



Up to 100 for the
PLU number

3. Press 1 of the 16 Department key that PLU is about to link to finalise the programming.



Status and Preset Price of Plu & Department

The features involved in this programming on the *ER-180* have been preset Open Price and non Single, tax1 (**Bold Font**) for Australia use. If change is needed, please determine preset price amount for N1 to N7, then refer to the table on next page; find out Status for N8, then,

NOTE: For N8, please refer to the setting on the “**Tax, Decimal Point Information**”.

For Department(s),

1. Turn mode key to **PGM** mode,
2. Enter the preset price up to 7 digits number,



3. Enter the option of Status,



4. Press Department key for the department you programming for to finalise the programming.



For PLU(s),

1. Turn mode key to **PGM** mode,
2. Enter the PLU number of the PLU that is modified, then **PLU** function key,



Up to 100 for the
PLU number

3. Enter the preset price up to 7 digits number,

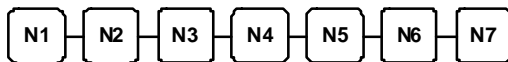

4. Enter the option of Status,



5. Press **PLU** key for the department you programming for to finalise the programming.



N8	In case VAT, add-on tax	In case external straight tax
0	Non single, non tax	Non single
1	Non single, tax1	Single
2	Non single, tax2	
3	Non single, tax3	
4	Non single,tax4	
5	Single, non tax	
6	Single, tax1	
7	Single, tax2	
8	Single, tax3	
9	Single,tax4	

Setting the Percent (%) Key

The percent (%) rate on the *ER-180* has been preset to open (**Bold Font**). If a preset value is needed, please refer to the table below (**For example: for 10%, enter 10000; for 5.55%, enter 05550; for 99.999%, enter 99999.**), then,

1. Turn mode key to **PGM** mode,
2. Enter the tax rate up to 5 digits number (*Do Not Use Decimal Point!*),

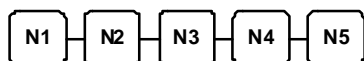

3. Press -% (for discount) or +% (for surcharge) key for the percent key you are programming for to finalise the programming.



	VALUE	COMMENTS
N1-N5	00000 - 99999 (00000 for 0% - open)	percent rate

Setting the Machine Number

The machine number is printed on the register receipt. Program a machine number so that any receipt can be identified with the store or register where the transaction took place.

1. Turn mode key to **PGM** mode,
2. Enter any 2 digits number followed by the **NO SALE** key.

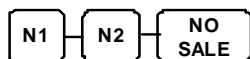

Receipt Print / Journal Print

The features involved in this programming on the *ER-180* have been preset to Taxable, tax amount print and Receipt Mode (**Bold Font**). If change is needed, please refer to the table below; find out the best option for both N1 and N2 from the table below, then,

1. Turn mode key to **PGM** mode,
2. Enter the number of your option of N1, then N2,



3. Press **X/TIME** key to finalise the programming.



	VALUE	COMMENTS
N1	0	Taxable, tax amount print
	1	Taxable, tax amount not print
N2	0	Receipt Mode
	1	Journal Mode

Rounding Option

The rounding system has been preset to Australia Rounding Use (**Bold Font**). If change is needed, please find out selection from the table below, then,

1. Turn mode key to **PGM** mode,
2. Enter the number of your option of N1,



3. Press - key to finalise the programming.



	VALUE	COMMENTS
N1	0	Australian Rounding Not use
	1	Australian Rounding Use

Training Mode

The Clerk System is preset to Normal Mode (**Bold Font**). If Training Mode is needed, please find out the value of Train Mode from the table below, then,

1. Turn mode key to **PGM** mode,
2. Enter the number of your option of N1,

N1

3. Press **CHARGE** key to finalise the programming.

CHARGE

	VALUE	COMMENTS
N1	0	Normal Mode
	1	Training Mode

System Options

There are two sets of options of System Options. To program System Option, the whole set of options need to enter all together at once, from N1, N2 ... to N5 then press RA (for option 1) or PO (for option 2). The Preset value has been highlighted (**Bold Font**). For example, if N2 option of option 1 is about to changed into NOT SKIP (value = 0), the whole 5 numbers have to be entered together as **0 0 0 0 0**, then **RA**.

Option 1

1. Turn mode key to **PGM** mode,
2. Enter the set of 5 number for the 5 options in option 1,

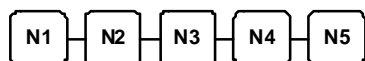

3. Press **RA** key to finalise the programming.



NO	OPTION	VALUE = 0	VALUE = 1
N1	CASH DECLARATION	NOT COMPULSORY	COMPULSORY
N2	ZERO SKIP IN REPORT	NOT SKIP	SKIP
N3	Z REPORT REPEAT	NOT REPEAT	REPEAT
N4	RF / VD / GROSS TOTAL PRINT IN REPORT	PRINT	NOT PRINT
N5	SUBTOTAL PRINT	PRINT	NOT PRINT

Option 2

1. Turn mode key to **PGM** mode,
2. Enter the set of 5 number for the 5 options in option 1,

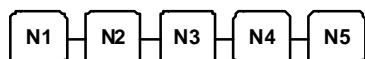

3. Press **PO** key to finalise the programming.



NO	OPTION	VALUE = 0	VALUE = 1
N1	GRAND TOTAL TO PRINT	PRINT	NOT PRINT
N2	GRAND TOTAL RESET AFTER Z REPORT	NOT RESET	RESET
N3	Z COUNTER RESET AFTER Z REPORT	NOT RESET	RESET
N4	CONSECUTIVE NUMBER AFTER Z REPORT	NOT RESET	RESET
N5	DATE PRINT	PRINT	NOT PRINT

Setting the Date

Use this program to set the clock and calendar on your **ER-180**. The date changes automatically. After initial setting, time changing will probably be required only for beginning and ending daylight savings time.

1. Turn mode key to **PGM** mode,
2. To program the time, press the 4 digit number keys to program in 24hrs format,



3. Press **CASH** key



4. To program the date, press 6 digit number keys to program in MMDDYY format,



5. Press the **CHECK** key.



Currency Conversion Rate

1. Turn mode key to **PGM** mode,
2. Enter the conversion rate without decimal point up to 5 digits number,

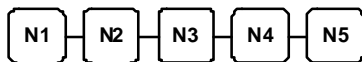

3. Enter the option of Status,



4. Press Department key for the department you programming for to finalise the programming.



	VALUE	COMMENTS
N1-N5	00000 - 99999	Conversion Rate
N6	0~5	Decimal Position

Ex) If conversion rate is 1.3720, then program 137204
If conversion rate is 13.72, then program 13722

System Balancing

NET SALES TOTAL = DEPARTMENT TOTALS (add positive, subtract negative)
+ TAX TOTAL (add-on, external straight tax version only)
+ % TOTAL
+ (-) TOTAL
GROSS SALES TOTAL = NET SALES TOTAL
- MERCHANDISE RETURN
- (-) TOTAL
- % TOTAL
ENDING GRAND TOTAL = GROSS SALES TOTAL
+ PREVIOUS GRAND TOTAL

Maintenance

1. Avoid excess dust and extreme temperatures.
2. Be certain that AC cord is inserted firmly in the outlet, and that cord poses no danger of accidental tripping.
3. Use no chemicals or abrasives while cleaning cabinet or keyboard.
4. Do not pull or hold paper while the register is printing.

JK68-60181A Rev. 1.12 (Oct 11)
From *ER-180* v1.000 to v1.001